



BRIK MB 80

MECHANICAL BRIQUETTING PRESS

BRICCHETTATRICE MECCANICA

COMPLETE PLANTS FOR THE PRODUCTION OF BRIQUETTES

IMPIANTI COMPLETI PER LA PRODUZIONE DI BRICCHETTI

 La bricchettatrice meccanica sviluppa una potenza di compressione di circa 2000 Kg per cm², ottenendo un bricchetto di alta qualità e peso specifico, con una notevole riduzione di volume, senza aggiunto di collanti. Il materiale da bricchettare deve essere celluloso e secco, avente una percentuale di umidità compresa tra il 10 ed il 14%. La produzione oraria si riferisce a materiale che abbia in origine allo stato sfuso, un peso specifico pari a circa 160 - 200 Kg/m³.

 The mechanical briquetting press develops a compression force of approximately 2000 Kg. per square centimeter to obtain a high quality briquette having a high specific weight and a remarkably reduced volume, without added adhesives. The briquetting material must be cellulosic and dry (having a moisture content between 10 and 14%). The hourly production refers to material which, in its original molten state, has a specific weight equal to approximately 160 - 200 Kg/cubic meter.

 Die mechanische Brikettierungsmaschine entwickelt eine Verdichtungsleistung von etwa 2.000 kg pro cm². Man erhält auf diese Weise ohne Zusatz von Klebern ein Brikett mit hohem spezifischem Gewicht und erheblich reduziertem Volumen. Das zu brikettierende Zellulosematerial muß trocken sein (mit einem Feuchtigkeitsgehalt zwischen 10 und 14%). Die Stundenleistung bezieht sich auf Material, das im ursprünglichen losen Zustand ein spezifisches Gewicht von etwa 160 - 200 kg/m³ hat.

 La presse à briquettes mécanique engendre une puissance de compression de 2000Kg env. par cm², ce qui produit une briquette de haut poids spécifique, avec une sensible réduction de volume, sans adjonction de colles. Les matériaux à presser doivent être celluloseux et secs (pourcentage d'humidité compris entre 10 et 14%). La production horaire se réfère à des matériaux ayant à l'origine un poids spécifique d'environ 160 - 200 Kg/m³.

 La briquetadora mecánica desarrolla una potencia de compresión de alrededor de 2000 kg per cm², obteniendo una briqueta de peso específico alto, con una notable reducción de volumen, sin anadidura de colas. El material que se preparará en briquetas tiene que ser celulósico y seco (con un porcentaje de humedad comprendido entre 10 y 14 %). La producción por hora se refiere a material que tenga un peso específico de alrededor de 160 - 200 kg/m³, en origen en el estado fundido.

 Механический брикетировочный пресс с силой прессования до 2000 кг/см² предназначен для получения брикетов высокого качества – с высокой плотностью без добавления клея. Производительность в час зависит от типа материала. Брикетированный материал должен быть целлюлозосодержащим и сухим (уровень влажности 10-14%), его плотность 160 - 200кг/м³.

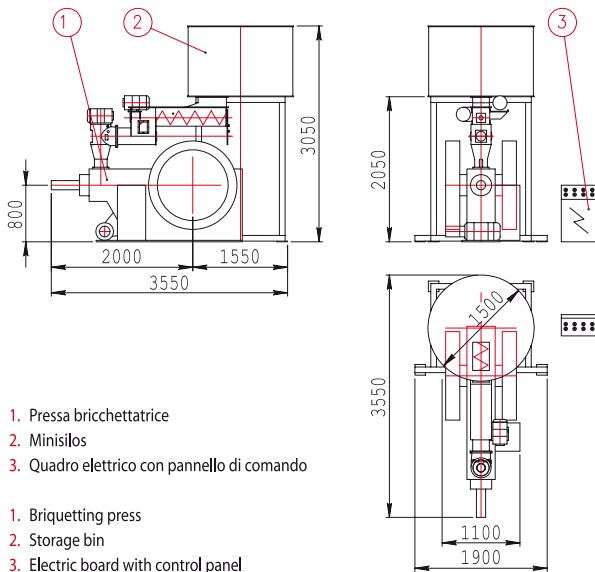

1. Pressa bricchettatrice
2. Minisilos
3. Quadro elettrico con pannello di comando

1. Briquetting press
2. Storage bin
3. Electric board with control panel



BRIK MB 80

Capacità produttiva Production capacity Produktionskapazität Capacité de production Capacidad de producción	Kg/h	700/1300
Diametro bricchetti Briquette diameter Brikettdurchmesser Diamètre des briquettes Diámetro briquetas	mm	80 (or square 70x70) (o quadrato 70x70)
Lunghezza bricchetti Length of briquettes Brikettlänge Longueur des bequettes Largo briquetas	mm	20-300
Potenza motore principale Main motor power Leistung Hauptmotor Puissance moteur principal Potencia motor principal	kW	45/55
Peso circa Approx. weight Gewicht zirka Poinds env. Peso aprox.	Kg	4800

PRESE BRICCHETTATRICI

Offriamo un programma completo per la compattazione di scarti di legno, scarti agricoli, scarti industriali, scarti comunitari e la loro trasformazione in pregiato combustibile per uso domestico o industriale, consentendo: comodità di stoccaggio, facilità di trasporto, significativi recuperi energetici, convenienza economica.

BRIQUETTING PRESSES

We offer a complete programme to compress wood, agricultural and industrial waste material as well as community garbage and transform it into fuel which can be used both for domestic and industrial purposes. This provides extremely easy storage, handling, energy recovery that can lead to an economic advantage.

- La ditta si riserva la facoltà di apportare modifiche tecniche o costruttive.
- The manufacturer reserves the right to make technical modifications.
- Die Firma behält sich das Recht zu möglichen technischen oder herstellungstechnischen Änderungen vor.
- Sous réserve de modifications techniques et de construction.
- La Firma se reserva la facultad de efectuar modificaciones técnicas y constructivas.

- Tutti i modelli di macchina sono costruiti nel rispetto della normativa europea "CE".
- All models produced are in compliance with the relevant "CE" European Standard.
- Alle Maschinenmodelle werden im Einklang mit der Europäischen "CE"-Norm hergestellt
- Tous les modèles de machine sont construits dans le respect de la normative européenne "CE"
- Todos los modelos de máquina son fabricados de conformidad con la normativa europea "CE"



DI PIU' s.r.l.
Via dei Fabbri, 11 - 36042 BREGANZE (VI) Italy
Tel. (+39) 0445 300709
Fax (+39) 0445 307567
Internet: www.di-piu.com
E-mail: info@di-piu.com

